

Double pitch conveyor chain attachments

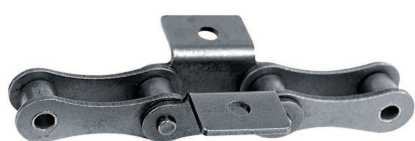

K-1

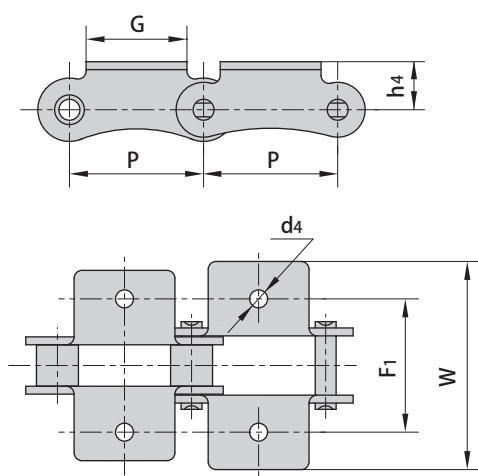

SK-1

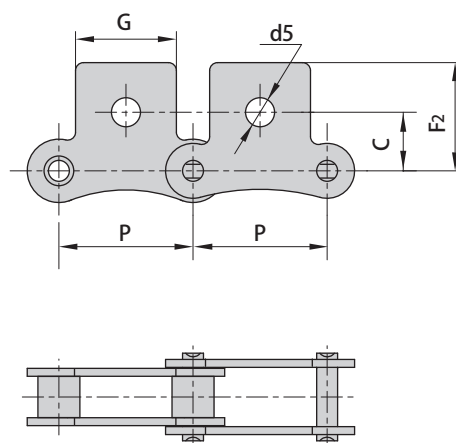

DIN/ISO Chain No.	ANSI Chain No.	P	G	F ₁	W	h ₄	d ₄	C	F ₂	d ₅
		mm	mm	mm	mm	mm	mm	mm	mm	mm
208A	2040	25.40	19.1	25.4	39.6	9.1	3.4	11.1	20.5	5.5
210A	2050	31.75	23.8	31.8	49.0	11.1	5.5	14.3	25.0	6.6
212A	2060	38.10	28.6	42.9	67.8	14.7	5.5	17.5	32.9	9.2
216A	2080	50.80	38.1	55.6	87.8	19.1	6.8	22.2	43.5	11.0
220A	2100	63.50	47.6	66.6	107.5	23.4	9.2	28.6	50.4	13.0
224A	2120	76.20	57.2	79.3	121.4	27.8	10.5	33.3	55.5	15.0
208B		25.40	23.2	25.4	39.6	9.1	4.5	11.1	20.5	5.5
210B		31.75	23.8	31.8	49.0	11.1	5.5			
212B		38.10	35.0	38.1	57.0	14.7	6.6			
216B		50.80	44.0	50.8	84.0	19.1	6.6			
220B		63.50	52.0	63.5	104.0	23.4	8.4			
224B		76.20	60.0	76.2	120.0	27.8	10.5			

Double pitch conveyor chain attachments

A-1

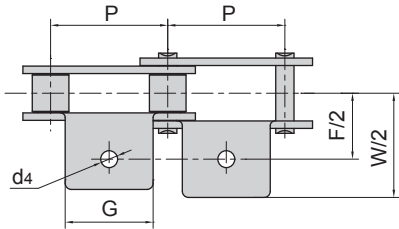

K-1

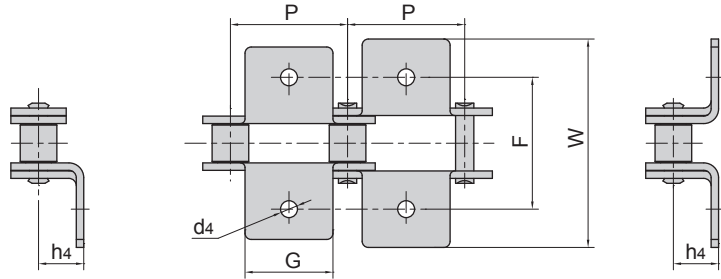

A-2

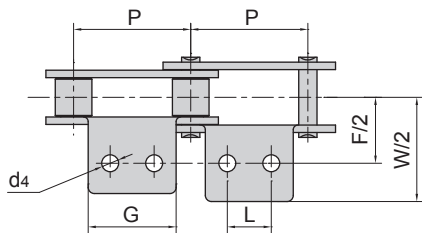

K-2

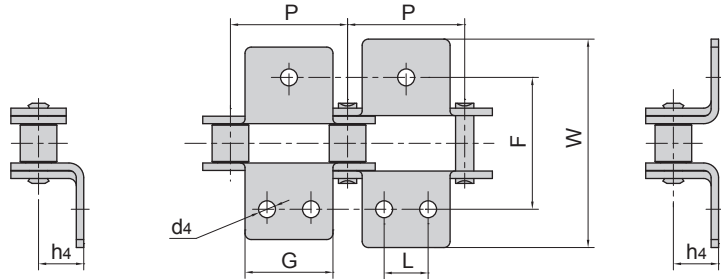

ISO Chain No.	ANSI Chain No.	P	G	L	F	W	h ₄	d ₄
		mm	mm	mm	mm	mm	mm	mm
C208A	C2040	25.40	19.1	9.5	25.4	39.6	9.1	3.4
C208AL	C2042		23.2	12.7	25.4	39.6	9.1	4.5
C210A	C2050	31.75	23.8	11.9	31.8	49.0	11.1	5.5
C210AL	C2052		28.6	14.3	42.9	67.8	14.7	5.5
C212A	C2060	38.10	28.6	14.3	42.9	67.8	14.7	5.5
C212AL	C2062		28.6	14.3	42.9	67.8	14.7	5.5
C212AH	C2060H	38.10	28.6	14.3	42.9	67.8	14.7	5.5
C212AHL	C2062H		50.80	38.1	19.1	55.6	87.8	19.1
C216A	C2080	50.80	38.1	19.1	55.6	87.8	19.1	6.8
C216AL	C2082		50.80	38.1	19.1	55.6	87.8	19.1
C216AH	C2080H	50.80	38.1	19.1	55.6	87.8	19.1	6.8
C216AHL	C2082H		63.50	47.6	23.8	66.6	107.5	23.4
C220A	C2100	63.50	47.6	23.8	66.6	107.5	23.4	9.2
C220AL	C2102		76.20	57.2	28.6	79.3	121.4	27.8
C220AH	C2100H	63.50	47.6	23.8	66.6	107.5	23.4	9.2
C220AHL	C2102H		76.20	57.2	28.6	79.3	121.4	27.8
C224A	C2120	76.20	57.2	28.6	79.3	121.4	27.8	11.0
C224AL	C2122		101.60	76.2	38.1	104.7	151.6	36.5
C224AH	C2120H	76.20	57.2	28.6	79.3	121.4	27.8	11.0
C224AHL	C2122H		101.60	76.2	38.1	104.7	151.6	36.5
C232A	C2160	101.60	76.2	38.1	104.7	151.6	36.5	13.1
C232AL	C2162		101.60	76.2	38.1	104.7	151.6	36.5
C232AH	C2160H	101.60	76.2	38.1	104.7	151.6	36.5	13.1
C232AHL	C2162H							

Double pitch conveyor chain attachments

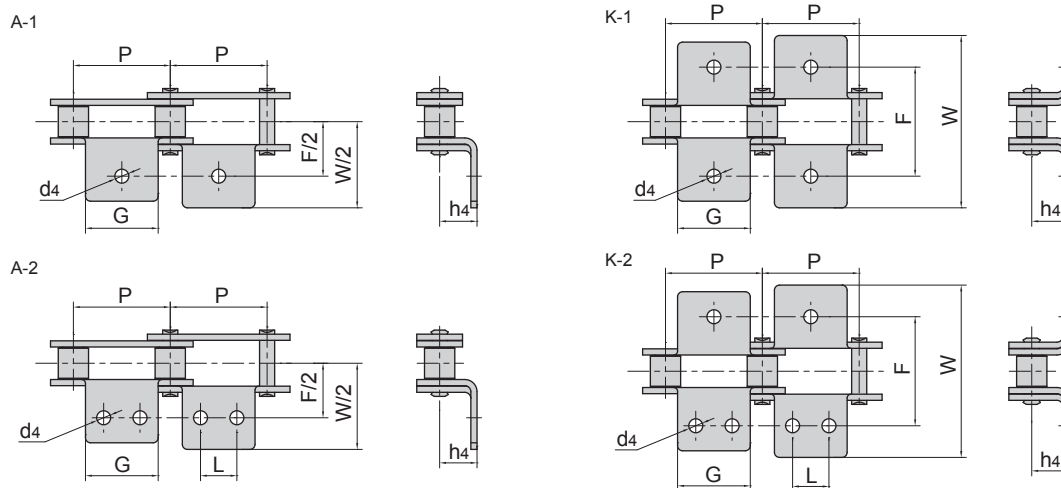

Donghua Chain No.	P	G	L	F	W	h ₄	d ₄
	mm	mm	mm	mm	mm	mm	mm
C208AF1	25.40	19.0	-	25.7	38.3	8.8	4.10
C2042F1	25.40	19.0	-	25.4	40.0	9.0	5.20
C2040A1F3	25.40	19.0	-	25.4	38.2	19.8	5.30
C2042A1F4	25.40	19.0	-	25.4	39.6	9.1	5.00
C2040A2F1	25.40	19.0	9.00	25.4	38.4	9.0	5.20
C2042HK1F1	25.40	19.0	-	47.0	60.0	9.1	7.00
C2050A1F6	31.75	23.8	-	31.8	49.0	11.4	6.30
C2052A2F1	31.75	19.0	11.90	31.8	49.0	11.1	6.00
C2052A2F2	31.75	19.0	15.88	31.8	49.0	11.1	5.50
C2052A2F3	31.75	25.8	12.70	31.8	49.2	11.1	4.80
C2060K1F1	38.10	28.6	-	42.9	68.0	14.7	8.50
C2062HK1F5	38.10	28.6	-	42.9	67.8	14.7	7.90
C2062A1F13	38.10	30.0	-	70.2	98.0	14.7	8.50
C2062A2F6	38.10	28.6	14.30	42.9	67.8	14.7	6.00
C2062K2F7	38.10	28.6	14.30	42.9	67.8	14.7	6.50
C2060HF3A2	38.10	28.6	14.30	42.9	67.8	14.7	5.20
C2062HF15	38.10	28.6	14.30	42.9	67.8	14.7	M5
C2060HK1F	38.10	28.6	-	42.9	67.8	14.7	8.00
C2062HA1F4	38.10	20.0	-	45.8	65.8	9.0	6.80
C2062HK1F5	38.10	28.6	-	42.9	67.8	14.7	7.90
C2062HA1F7	38.10	28.6	-	42.9	67.8	14.7	5.20
C2060HA1F12	38.10	28.0	-	43.4	61.8	13.9	6.60
C2060HK2F3	38.10	28.6	14.30	42.9	64.8	14.7	5.00
C2062HK2F4	38.10	28.6	14.30	42.9	56.4	14.7	5.20
C2062HK2F5	38.10	28.6	14.30	55.6	76.0	11.1	5.50
C2060HK1F26	38.10	28.6	-	42.9	67.8	14.7	9.20
C2062HA1F25	38.10	28.0	-	59.0	75.0	9.0	6.00
C2062A2F22	38.10	28.6	14.30	42.9	57.4	14.7	5.50
C2060HK1F22	38.10	28.6	-	42.9	67.8	14.7	8.50
C2062A2F24	38.10	28.6	14.30	42.9	67.8	14.7	4.76
C216AF3	50.80	39.0	19.10	59.0	78.5	23.0	7.00
C2082A2F1	50.80	39.0	19.00	58.0	82.0	21.5	7.00

Double pitch conveyor chain attachments

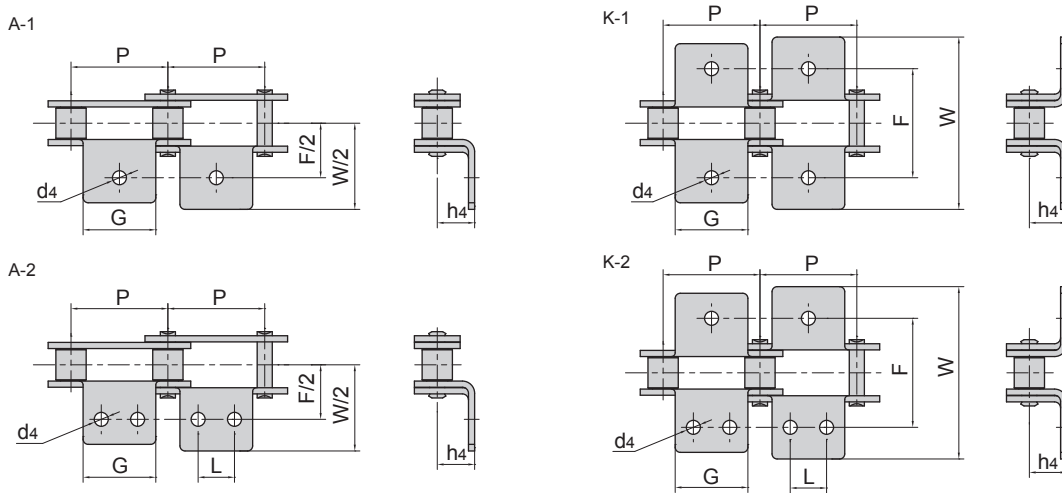

Donghua Chain No.	P	G	L	F	W	h4	d4
	mm	mm	mm	mm	mm	mm	mm
C2082A2F2	50.80	39.0	19.00	58.0	82.0	21.50	10.00
C2082K2F5	50.80	38.1	19.10	120.0	140.0	19.10	6.80
C2080HF	50.80	38.1	19.10	55.6	75.2	17.80	10.00
C2082HK1F5	50.80	38.1	-	55.6	79.6	19.10	8.00
C2082HA1F6	50.80	38.1	-	55.6	77.8	19.10	10.00
C2082HK1F7	50.80	38.1	-	55.6	79.6	19.10	6.50
C2080HK1F8	50.80	38.1	-	55.6	87.8	19.10	9.00
C2082HK1F9	50.80	38.1	-	55.6	81.5	19.10	M8
C2080HA1F12	50.80	38.1	19.1	55.6	73.0	19.10	8.10
C2080HK1F13	50.80	38.1	-	55.6	80.0	19.10	9.00
C2082HA1F17	50.80	38.1	-	55.6	87.8	19.10	9.50
C2080HSLRA2F5	50.80	38.1	22.2	63.5	87.8	19.05	8.80
C2082HA2F6	50.80	38.1	19.1	55.6	87.8	19.10	8.00
C2082F64K2	50.80	34.9	20.0	54.0	79.0	16.00	M6
C2082HA1F21	50.80	38.1	-	55.6	88.3	19.10	10.20
C2080HSLRA2F23	50.80	38.1	19.1	55.6	87.8	19.10	M8
C2082A1F22	50.80	38.1	-	49.6	76.2	16.00	10.50
C2082HK1F23	50.80	38.1	-	55.6	87.8	19.10	8.00
C2082HA2F22	50.80	60.0	40.0	62.6	82.6	39.50	9.00
C2082A2F23	50.80	65.0	44.0	62.0	86.0	19.40	7.00
C2100HK1F1	63.50	47.6	-	66.0	92.0	25.00	12.50
C220ALA2F5	63.50	52.0	31.0	66.6	107.4	23.40	9.20
C220AHK1F1	63.50	47.6	-	66.0	92.0	25.00	12.50
C2102HA2F3	63.50	47.6	23.8	66.6	99.8	23.40	3/8"
C220AHA2F2	63.50	47.6	23.8	66.6	107.5	23.40	9.20
C220ALA1F5	63.50	47.6	-	76.6	107.5	23.40	11.00
C224AHK2F2	76.20	72.0	40.0	79.3	121.4	27.80	13.00
C2162HA2F2	101.60	36.5	38.1	104.7	151.6	36.50	18.00
C208BHK1F7	25.40	23.2	-	25.4	39.6	9.10	6.50
C208BA1F8	25.40	14.8	-	25.6	37.8	9.80	5.50

Double pitch conveyor chain attachments

AA-1

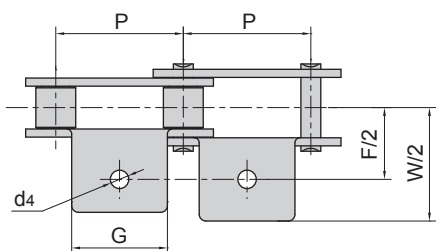

AA-2

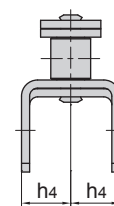
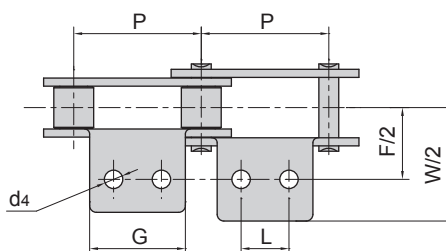

KK-1

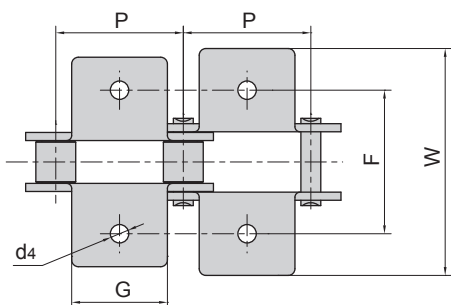

KK-2

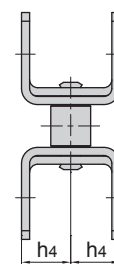
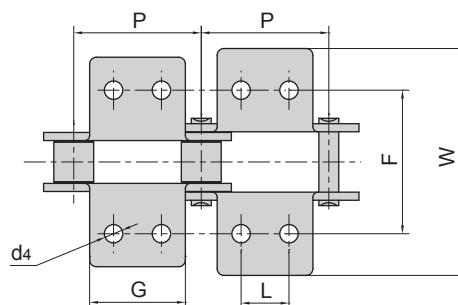

Donghua Chain No.	ANSI Chain No.	P	G	L	F	W	h4	d4
		mm	mm	mm	mm	mm	mm	mm
C208A C208AL	C2040 C2042	25.40	19.1	9.5	25.4	39.6	9.1	3.4
C208B C208BL		25.40	23.2	12.7	25.4	39.6	9.1	4.5
C210A C210AL	C2050 C2052	31.75	23.8	11.9	31.8	49.0	11.1	5.5
C212A C212AL	C2060 C2062	38.10	28.6	14.3	42.9	67.8	14.7	5.5
C212AH C212AHL	C2060H C2062H	38.10	28.6	14.3	42.9	67.8	14.7	5.5
C216A C216AL	C2080 C2082	50.80	38.1	19.1	55.6	87.8	19.1	6.8
C216AH C216AHL	C2080H C2082H	50.80	38.1	19.1	55.6	87.8	19.1	6.8
2060AA2F1		38.10	38.1	19.0	37.5	57.5	14.8	6.5
C2062AA1F1		38.10	14.0	-	33.4	52.0	9.0	6.4
C2080K1F4		50.80	38.1	-	80.0	112.0	15.3	8.5
C2082HAA1F1		50.80	25.0	-	78.8	128.8	17.5	8.0
C2082HAA1F2		50.80	25.0	-	77.8	127.8	17.5	12.0
C2122HAA1		76.20	57.2	-	79.3	121.4	27.8	11.0

Double pitch conveyor chain attachments

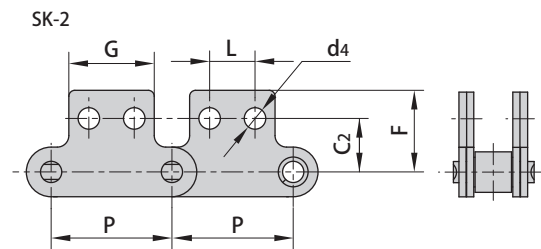
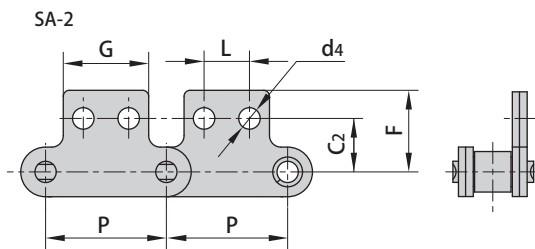
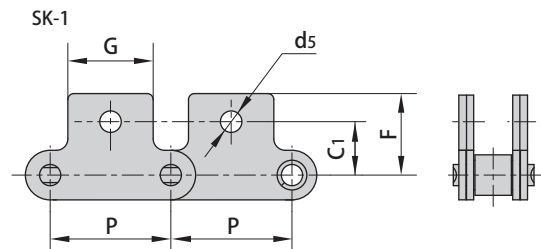
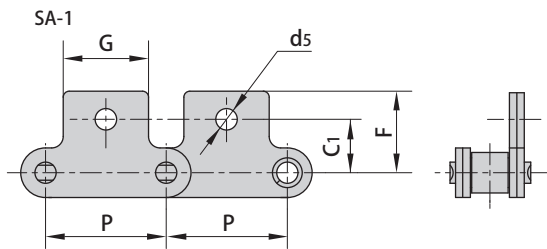

Donghua Chain No.	ANSI Chain No.	P	G	L	C ₁	C ₂	F	d ₄	d _s
		mm	mm	mm	mm	mm	mm	mm	mm
C208A	C2040	25.40	19.10	9.50	11.1	13.50	20.5	3.4	5.50
C208AL	C2042		23.20	12.70					
C208B		25.40	23.20	12.70	11.1	13.50	20.5	4.5	5.50
C208BL									
C210A	C2050	31.75	23.80	11.90	14.3	15.90	25.0	5.5	6.60
C210AL	C2052								
C212A	C2060	38.10	28.60	14.30	17.5	19.10	32.9	5.5	9.20
C212AL	C2062								
C212AH	C2060H	38.10	28.60	14.30	17.5	19.10	32.9	5.5	9.20
C212AHL	C2062H								
C216A	C2080	50.80	38.10	19.10	22.2	25.40	43.5	6.6	11.00
C216AL	C2082								
C216AH	C2080H	50.80	38.10	19.10	22.2	25.40	43.5	6.6	11.00
C216AHL	C2082H								
C220A	C2100	63.50	47.60	23.80	28.6	31.80	50.4	8.4	13.00
C220AL	C2102								
C220AH	C2100H	63.50	47.60	23.80	28.6	31.80	50.4	8.4	13.00
C220AHL	C2102H								
C2042HWSA2		25.40	37.30	9.50	-	13.50	20.5	3.4	-
C2050HWSA2F1		31.75	46.75	31.75	-	15.90	25.0	5.5	-
C2060SA2F1		38.10	28.60	14.30	-	19.10	26.1	5.5	-
C2062HSK2F1		38.10	28.60	14.30	-	19.10	23.8	5.2	-
C2060HSK1F1		38.10	28.60	-	17.3	-	30.0	-	11.80
C216AH2F		50.80	38.10	19.10	-	25.40	43.5	6.5	-
C2082F58SA1-P		50.80	38.50	-	27.0	-	39.5	-	8.10
C2080HSLRSA2F5		50.80	38.10	19.10	-	25.40	43.5	6.8	-
C2100HSA1		63.50	47.60	-	28.6	-	50.4	-	13.00
C224ALSK2F1		76.20	57.20	28.6	-	37.30	59.9	-	11.00
C2122HSA1F1		76.20	57.20	-	37.3	-	59.9	-	14.30
C224AHLSA2F1		76.20	57.20	28.6	-	37.30	59.9	-	9.53
208BSK1F2		25.40	14.00	-	17.7	-	21.3	-	3.20
208BSK1F3		25.40	13.00	-	14.7	-	26.7	-	3.10
208BSK1F4		25.40	24.20	-	14.3	-	20.5	-	4.20

Double pitch conveyor chain attachments

SAA-1

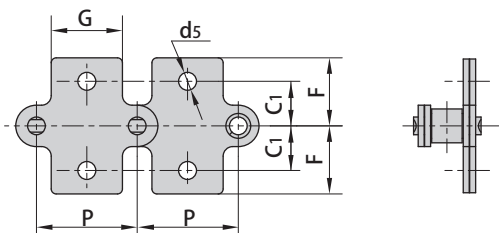

SKK-1

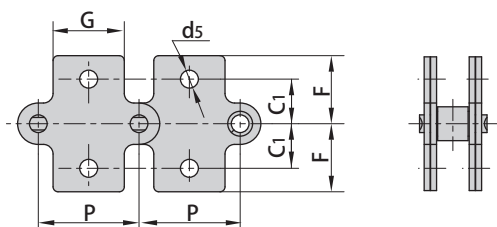

SAA-2

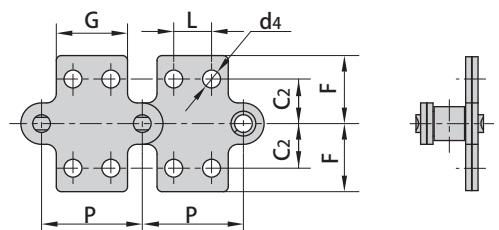

SKK-2

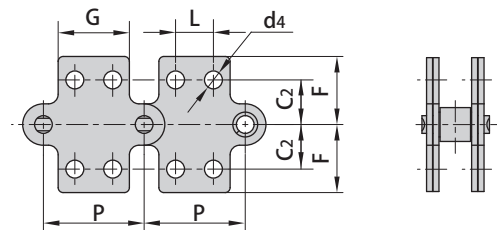

Donghua Chain No.	ANSI Chain No.	P	G	L	C1	C2	F	d4	d5
		mm	mm	mm	mm	mm	mm	mm	mm
C208A C208AL	C2040 C2042	25.40	19.1	9.5	11.1	13.5	20.5	3.4	5.5
C208B C208BL		25.40	23.2	12.7	11.1	13.5	20.5	4.5	5.5
C210A C210AL	C2050 C2052	31.75	23.8	11.9	14.3	15.9	25.0	5.5	6.6
C212A C212AL	C2060 C2062	38.10	28.6	14.3	17.5	19.1	32.9	5.5	9.2
C212AH C212AHL	C2060H C2062H	38.10	28.6	14.3	17.5	19.1	32.9	5.5	9.2
C216A C216AL	C2080 C2082	50.80	38.1	19.1	22.2	25.4	43.5	6.6	11.0
C216AH C216AHL	C2080H C2082H	50.80	38.1	19.1	22.2	25.4	43.5	6.6	11.0
C2060HSAA1F1		38.10	24.0	-	25.4	-	43.5	11.0	-

Double pitch conveyor chain attachments

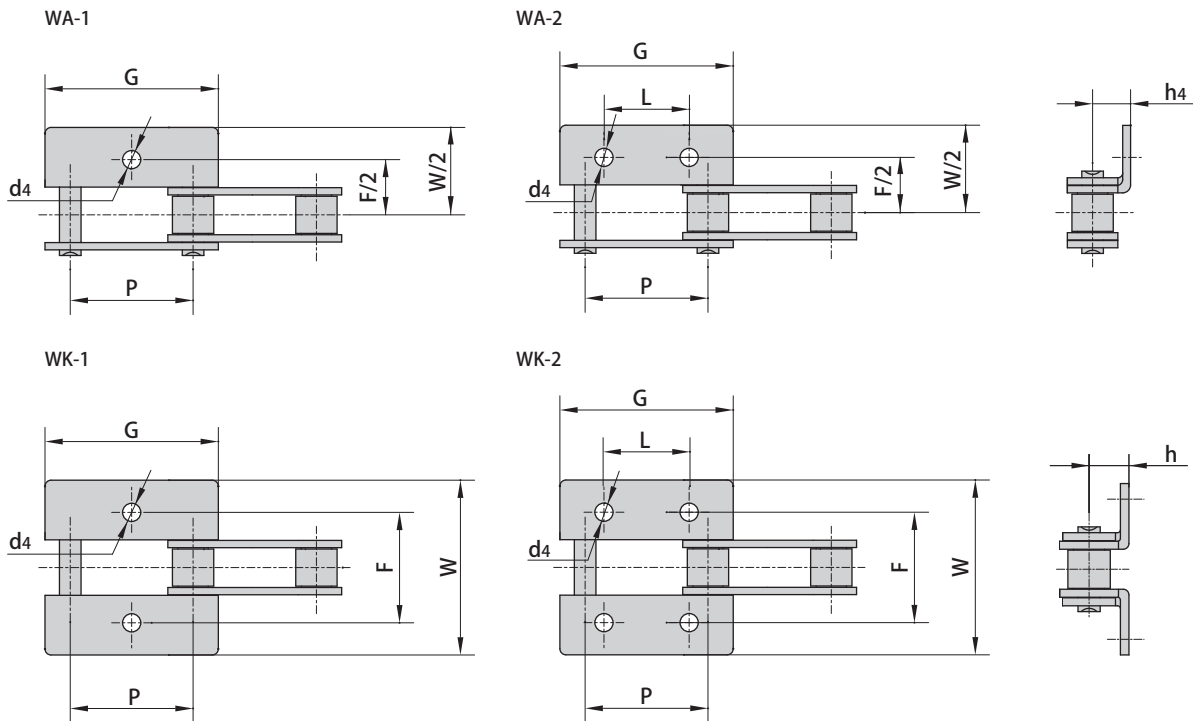

Donghua Chain No.	P	G	L	F	W	h4	d4
	mm	mm	mm	mm	mm	mm	mm
C2040K1F2	25.40	37.0	-	62.0	110.0	9.1	7.0
C2042HF1	25.40	37.4	-	42.5	65.5	6.0	7.0
C2052WA1F2	31.75	46.8	-	76.2	95.2	7.5	7.1
C2062WA2F1	38.10	56.1	38.1	42.9	67.8	14.7	6.5
C2062WK2F2	38.10	56.1	38.1	43.0	68.0	14.7	7.8
C2062HWA1F4	38.10	55.6	-	76.2	95.3	8.7	7.1
C2062HWA2	38.10	56.1	14.3	42.9	67.8	14.7	5.5
C2062HWA2F4	38.10	55.6	38.1	76.2	95.3	8.7	7.1
C2060WA2	38.10	56.1	38.1	42.9	58.5	14.7	5.5
C216ALF5	50.80	74.8	44.3	62.2	88.0	19.1	7.0
C2082F12	50.80	74.8	50.8	55.6	88.0	19.1	8.4
C2082F24	50.80	74.8	56.8	55.6	87.8	19.1	6.8
C2082HF1A2	50.80	74.8	30.0	60.0	84.0	18.0	8.5
C2080HWK2	50.80	74.8	50.8	55.6	87.8	19.1	6.8
C2082WA2F4	50.80	74.8	50.8	55.6	88.0	14.0	7.0
C2100HWA2	63.50	93.5	63.5	66.6	107.4	23.4	8.4
C224AHWK2	76.20	111.9	76.2	79.3	111.9	27.8	11.0
C2102HK2-M8	63.50	47.6	23.8	66.6	107.5	23.4	M8
C208BK2F	25.40	37.2	12.7	28.0	42.0	8.5	5.5
212BWK2F1	38.10	54.1	19.0	35.2	54.8	12.2	6.4
212BWK2F2	38.10	54.1	19.0	35.0	54.8	12.7	7.0
216BWA2F1	50.80	71.8	25.4	58.0	80.0	17.0	8.4